

Cestelli estraibili

ART. 301

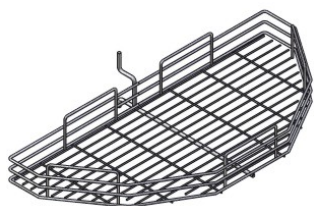

ART.	Per corpo mobile da	L cm	P.D cm	H. cm	Finitura
CE301S76NI	90	76	36	8,5	CROMO

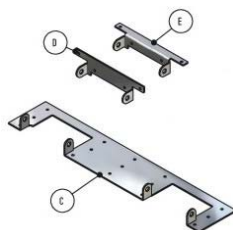

Specificare attacchi all'ordine.

Cestelli estrazione totale con guida quadro ammortizzata

ART. 1104 Y



ART.	Per corpo mobile da	L cm	P.D cm	H. cm	Finitura
CE1104Y1550NI	15	10	50	50	CROMO
CE1104Y2050NI	20	13	50	50	CROMO

ART. 1102 Y



ART.	Per corpo mobile da	L cm	P.D cm	H. cm	Finitura
CE1102Y3050NI	30	25	50	50	CROMO
CE1102Y3550NI	35	30	50	50	CROMO
CE1102Y4050NI	40	35	50	50	CROMO
CE1102Y4550NI	45	40	50	50	CROMO
CE1102Y5050NI	50	45	50	50	CROMO
CE1102Y6050NI	60	55	50	50	CROMO

ART. 1202 Y

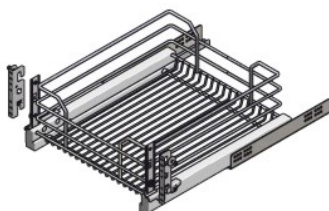

ART.	Per corpo mobile da	L cm	P.D cm	H. cm	Finitura
CE1202Y4550NI	45	41,4	50	17	CROMO
CE1202Y9050NI	90	86,4	50	17	CROMO

Meccanismi estraibili

ART. 803

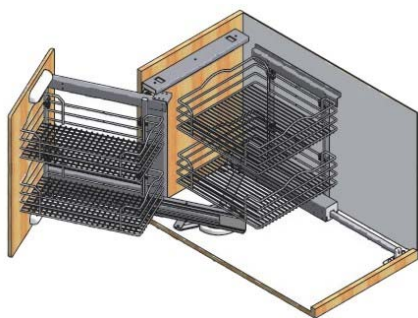

ART.	Per corpo mobile	L cm	P.D cm	H. cm	Finitura
ME803BDXNI	90	86	48/56	60/85	MECC. GRIGIO CEST.CROMO
ME803BSXNI	90	86	48/56	60/85	MECC.GRIGIO CEST.CROMO

ESEMPIO DISEGNO DESTRO

SPECIFICARE SE DX o SX

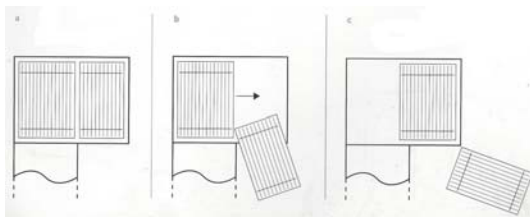

ART. 850 A - M - B - S



ART.	Per corpo mobile	P.D cm	H. cm	Finitura
ES850A	30-40- 45-50- 60	44-49	182,5/ 218,5	MECC.GRIG. CEST.CROMO
ES850M	30-40- 45-50- 60	44-49	148/ 186	MECC.GRIG. CEST.CROMO
ES850B	30-40- 45-50- 60	44-49	113,5/ 149,5	MECC.GRIG. CEST.CROMO
ES850S	30-40- 45-50- 60	44-49	0,79/ 115	MECC.GRIG. CEST.CROMO

CESTELLI DA ORDINARE A PARTE (NON COMPRESI NEL PREZZO)

ART. 1204

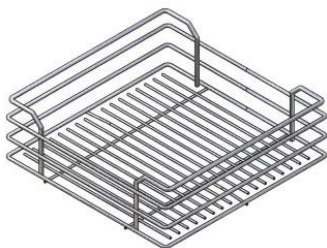

ART.	Per corpo mobile da	L cm	P.D cm	H. cm	Finitura
CE12043050NI	30	23	42	12	CROMO
CE12044550NI	45	38	42	12	CROMO
CE12046050NI	60	53	42	12	CROMO

Meccanismi per angoli

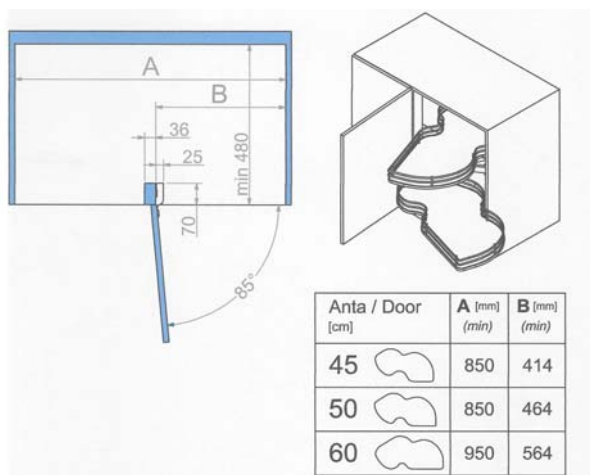
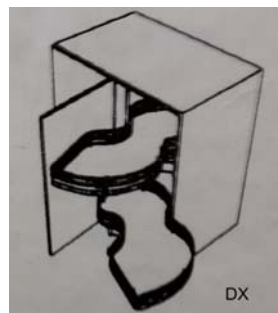

Finitura Cromo Bianco: Cesto filo cromato, pannello bianco, struttura verniciato RAL 7035

Finitura Cromo Grigio : Cesto filo cromato, pannello grigio, struttura verniciato RAL 9006

ART.	Larghezza anta	Finitura
KI846BE45BI	45 (DX/SX)	Finitura cromo con piano bianco O Finitura cromo con piano grigio
KI846BE50BI	50 (DX/SX)	
KI846BE60BI	60 (DX/SX)	

Cesto portabiancheria

ART. 2123 ASY senza attacco anta

Guida quadro ammortizzata.

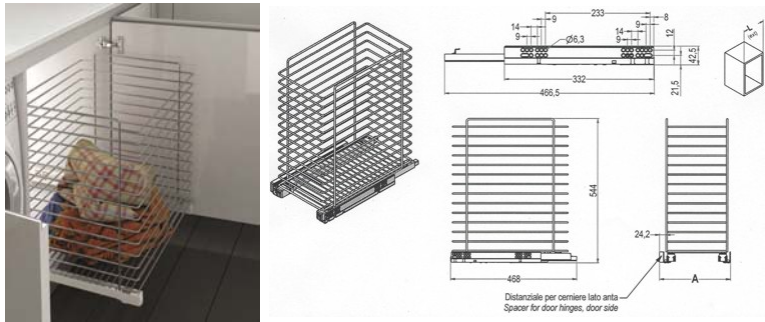

ART.	Per corpo mobile da	A mm	P.D mm	H. mm	Finitura
CE2123ASY3045NI	300	264	468	544	Nichelato
CE2123ASY4045NI	400	364	468	544	Nichelato
CE2123ASY4545NI	450	414	468	544	Nichelato
CE2123ASY5045NI	500	464	468	544	Nichelato
CE2123ASY6045NI	600	564	468	544	Nichelato

La misura A è regolabile + / - 2 mm

ART. 2123 SY con attacco all'anta

Guida quadro ammortizzata.

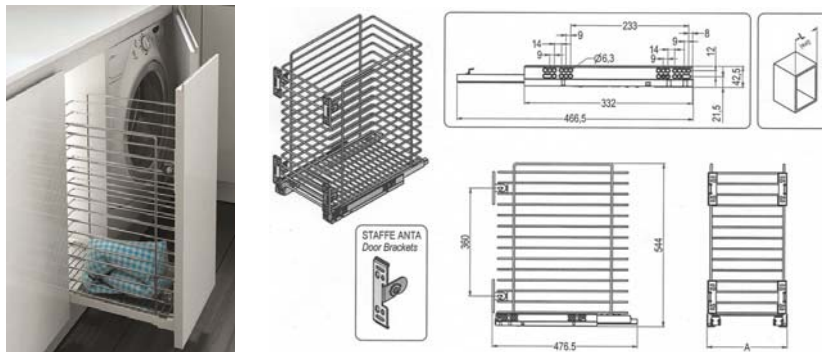

ART.	Per corpo mobile da	A mm	P.D mm	H. mm	Finitura
CE2123SY4045NI	400	364	477	544	Nichelato
CE2123SY4545NI	450	414	477	544	Nichelato
CE2123SY5045NI	500	464	477	544	Nichelato
CE2123SY6045NI	600	564	477	544	Nichelato

La misura A è regolabile + / - 2 mm

ART. 125



ART.	Per corpo mobile da	L mm	P.D mm	H. mm	Finitura
CE12530NI	300	250	270	400/500	Nichelato
CE12535NI	350	300	270	400/500	Nichelato
CE12540NI	400	350	270	400/500	Nichelato
CE12545NI	450	400	270	400/500	Nichelato
CE12550NI	500	450	270	400/500	Nichelato
CE12560NI	600	550	270	400/500	Nichelato

