

# COMPRESSORI

**Gruppi pompanti interamente realizzati in alluminio pressofuso, non lubrificati e senza manutenzione.**

Queste caratteristiche garantiscono aria senza impurità per gli utilizzi più delicati e semplice trasportabilità, non esistono nessun pericolo di fuoriuscite di olio anche nel caso in cui il compressore sia coricato su un lato.

**Involucri realizzati in plastica robusta.**

Coprono completamente tutte le parti meccaniche interne ed impediscono il contatto accidentale con parti in movimento o che si riscaldano durante l'utilizzo.

## ART. Spider 6



CODICE	POTENZA HP/KW	CILINDRI	PRESSIONE MAX	ARIA ASPIRATA L/Min/ CFM	TENZIONE Volt/Hz	PESO Kg.	DIMENSIONI L x P x A
COSP6	1,5/1,1	1	8/116	180/6,4	230/50	9,5	355x315x370

## ART. Spider 24 V



CODICE	POTENZA HP/KW	CILINDRI	PRESSIONE MAX	ARIA ASPIRATA L/Min/ CFM	TENZIONE Volt/Hz	PESO Kg.	DIMENSIONI L x P x A
COSP24V	1,5/1,1	1	10/145	180/6,4	230/50	13,5	365x365x620

## ART. Spider 24





CODICE	POTENZA HP/KW	CILINDRI	PRESSIONE MAX	ARIA ASPIRATA L/Min/ CFM	TENZIONE Volt/Hz	PESO Kg.	DIMENSIONI L x P x A
COSP24	1,5/1,1	1	8/116	180/6,4	230/50	20	570x255x445

# UTENSILERIA ARIA

**ART. 9020 /1 F**

## **9020/1F** Trapano reversibile da 3/8" / 3/8" reversible air drill

TYPE	 r.p.m.	 AIR l/sec.	 bar - p.s.i.	 BSP	 kg - lbs	 Pack.
308902010	2200	2,1	6,3 - 90	1/4"	1,2 - 2.6	

Impugnatura Soft Touch. Lo scarico nell'impugnatura dirige il flusso d'aria lontano dall'oggetto su cui si lavora e riduce il livello di rumorosità.









NEW

ART.	Descrizione
TR90201F	TRAPANO REVERSIBILE

**ART. 9530 /1F**

## **9530/1F** Cacciavite diritto da 1/4" / Straight screw driver 1/4"

TYPE	 r.p.m.	 bar - p.s.i.	 MAX mm	 AIR l/sec.	 Ø mm	 BSP	 kg - lbs	 Pack.
308953001	1700	6 - 87	7	4	10	1/4"	2 - 4.4	

Ideale per lavorare sul legno, sui pannelli di cartone e per fare lavori in linea di montaggio. Il pulsante per l'inversione è azionabile con una sola mano. Il gancio posteriore consente un facile uso dell'utensile lungo le linee di montaggio. La frizione regolabile consente all'operatore di controllare il serraggio della vite.



ART.	Descrizione
TR95301F	Cacciavite diritto

# UTENSILERIA ARIA



## 9060/F Levigatrice orbitale / *Orbital sander*

TYPE	r.p.m.	bar - p.s.i.	AIR l/sec.	BSP	kg - lbs	Pack.
308906000	8000	6 - 87	5	1/4"	1,85 - 4.08	

Per smerigliare, levigare, togliere la ruggine.  
Completa di 3 dischi con diametro di 77, 114 e 140 mm  
per piattorelli reperibili in commercio.

### ART. 9060 /F

ART.	Descrizione
LE9060F	LEVIGATRICE ORBITALE

### ART. 9070 /F



## 9070/F Levigatrice mini / *Mini sander*

TYPE	r.p.m.	bar - p.s.i.	AIR l/sec.	BSP	kg - lbs	Pack.
308907000	14500	6 - 87	3,67	1/4"	0,55 - 1.21	

Piccola, leggera e maneggevole. Per togliere la vernice,  
levigare e restaurare mobili, telai di finestre, sedie ecc.  
Completa di tubo di alimentazione da 2 metri.  
Dimensione piattorello 75 x 82 mm.

ART.	Descrizione
LE9070F	LEVIGATRICE ORBITALE

### ART. 9070 /4F



## 9570/4F Levigatrice a disco con aspirazione e accessori / *Disc honing machine with su*

TYPE	r.p.m.	bar - p.s.i.	AIR l/sec.	O mm	BSP	kg - lbs	Pack.
308957001	10000	6 - 87	6,67	10	1/4"	1,2 - 2.65	

Ideale per la rimozione di ruggine e la lucidatura di tutte  
le superfici dell'automobile. Dotata di sistema aspirazione  
polveri. Dimensione piattorello 150 mm.

ART.	Descrizione
LE95704F	LEVIGATRICE ROTO ORBITALE

# AVVOLGITORI ARIA

**ART. 804300**

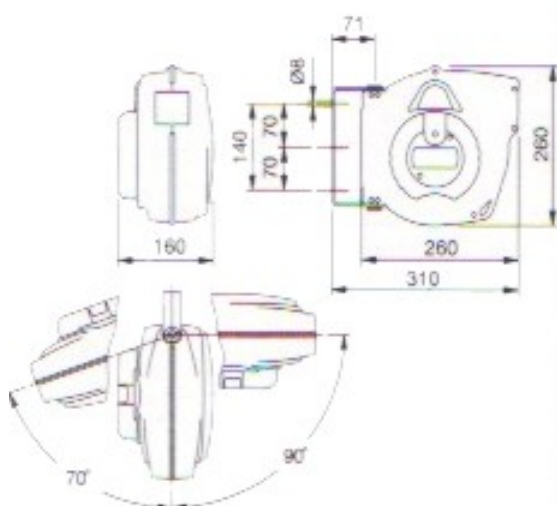

CODE	NAME								
804300	ROLL CLASSIC PLUS AIR/10	10m	6x10	1/4"	10Bar	•	96	27,5x27,5x19	5Kg

**AV804300**

# AVVOLGITORI ELETTRICI

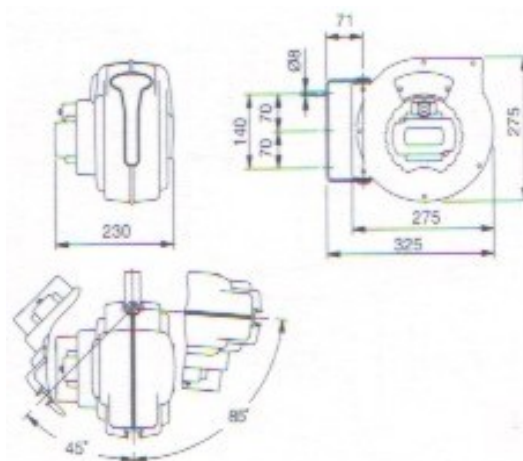

Nxmm <sup>2</sup>				CABLE			ART.	MT
							811190	10
							811020	15

MAVEL 01

3G 1,5mm<sup>2</sup>      TÜV      H05VV-F      800W      2000W

# Connessioni Pneumatiche

## ART. 8

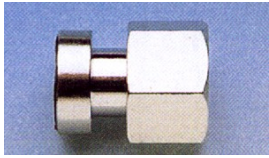

-Testina a baionetta  
-Maschio

COD.	Filetto	Tubo
814	1/4	

## ART. 9A

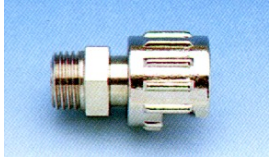

-Raccordo con dado per attacco a baionetta  
-Maschio

COD.	Filetto	Tubo
9A14	1/4	

## ART. 9C

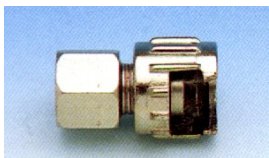

-Raccordo con dado per attacco a baionetta  
-Femmina

COD.	Filetto	Tubo
9C14	1/4	

## ART.10A

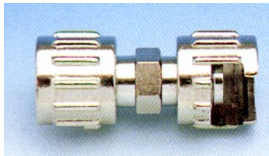

-Raccordo di giunzione con due dadi per attacco a baionetta

COD.	Filetto	Tubo
10A14	1/4	

## ART.11A



-Dado cappettato per attacco a baionetta

COD.	Filetto	Tubo
11A14	1/4	

## ART.15A1U

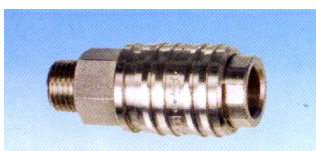

-Rubinetto universale portagomma per innesto I D S USA  
-Maschio

COD.	Filetto	Tubo
15A1U14	1/4	
15A1U38	3/8	

## ART. 15C1U

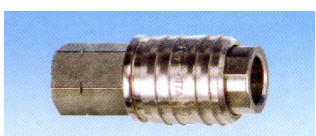

-Rubinetto universale per innesto I D S USA  
-Femmina

COD.	Filetto	Tubo
15C1U14	1/4	

## ART. 13AM



-Innesto per rubinetto rapido  
-Maschio

COD.	Filetto	Tubo
13AM14	1/4	
13AM38	3/8	

## ART. 13AF



-Innesto femmina per rubinetto  
-Femmina.

COD.	Filetto	Tubo
13AF	1/4	



# PISTOLE ARIA

## ART.27 A



ART.	EURO €
PI27A	

- Pistola soffiaggio aria
- Corpo in alluminio super leggero.

## ART.27 B

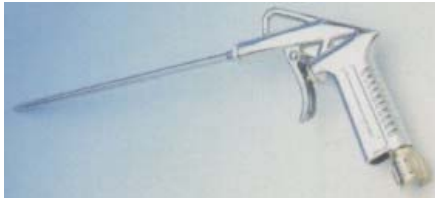

ART.	EURO €
PI27B	

- Pistola soffiaggio aria canna lunga
- Corpo in alluminio super leggero.

## ART.27 P



ART.	EURO €
PI27P	

- Pistola soffiaggio aria
- Elevata portata molto silenziosa

## ART.27 G



Attacchi02

ART.	EURO €
PI27G	

- Pistola con manometro Ø 63