

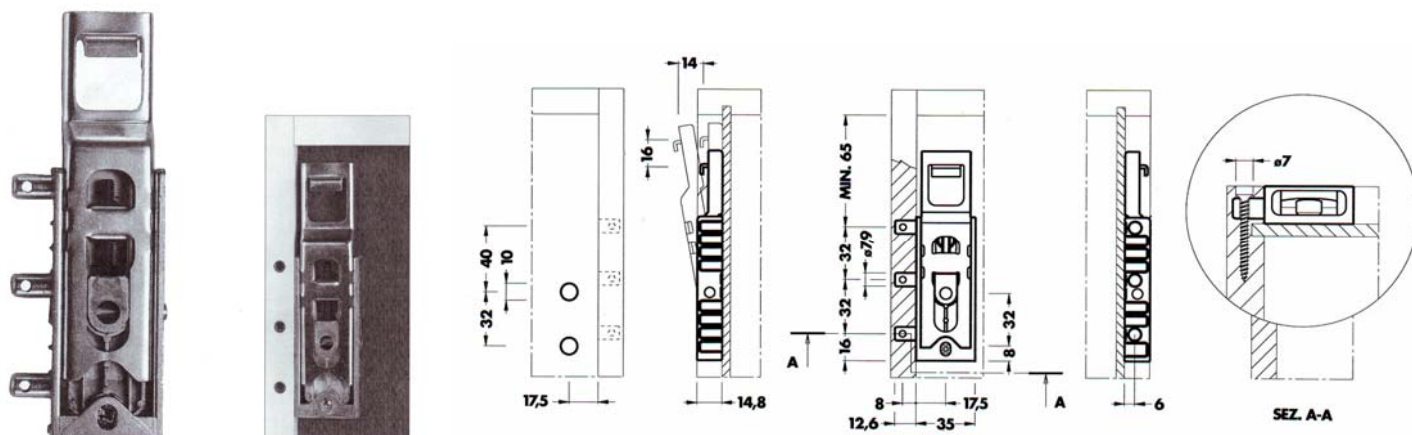

## ART. 815 P



<b>CODICE</b>	<b>Pz. Conf</b>	
<b>AT815P</b>	1-50	

DX-SX

## ART. 815 G

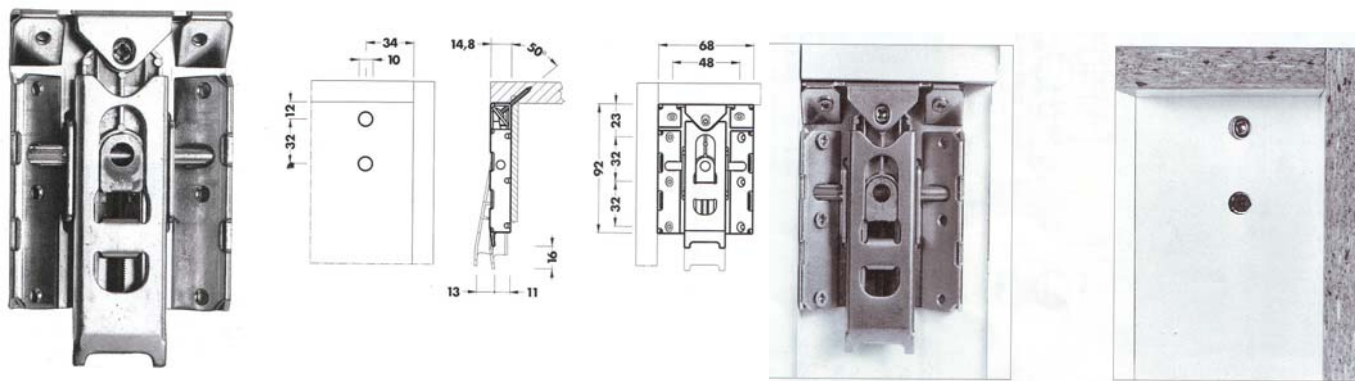

<b>CODICE</b>	<b>Pz. Conf</b>	
<b>AT815G</b>	1-50	

## ART. 875

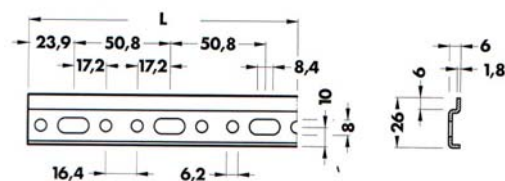

CODICE	Lunghezza mm	Altezza Mm	Pz. Conf
<b>BA875ZI</b>	2000	26	1-10

## ART. 41

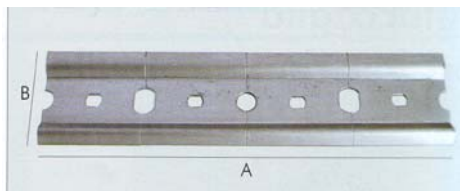

CODICE	A mm	B mm	Th1	Pz. Conf
<b>BA41</b>	2000	50	1,2	1-10

## ART. 267

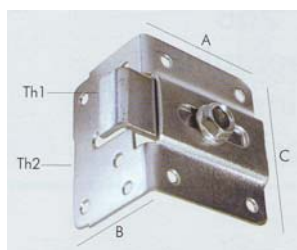

CODICE	A mm	B mm	C mm	Th1	Th2	Materiale	Pz. Conf
<b>AT267</b>	45	36	51	2.5	1.2	Ferro zincato	1-200

## ART. 501

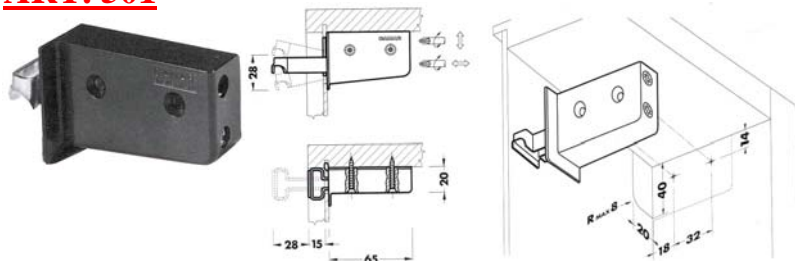

CODICE	Colore	Pz. Conf
<b>AT501BI</b>	Bianco	1-200 DX 1-200SX
<b>AT276MA</b>	Marrone	1-200 DX 1-200SX

## ART. 806

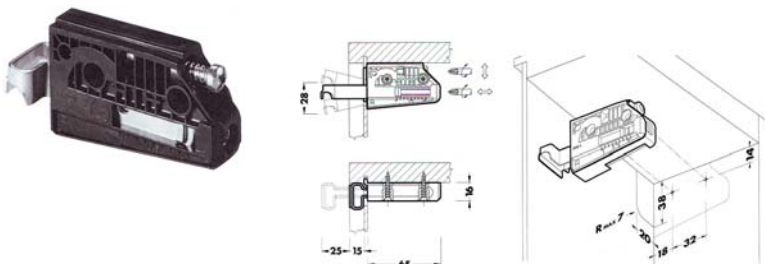

CODICE	Colore	Pz. Conf
<b>AT806</b>	Nero	1-200 DX 1-200SX

## ART. 806 GUSCIO PER 806



CODICE	Colore	Pz. Conf
<b>GU806NS</b>	Nichel satinato	1-200 DX 1-200SX

## ART.36



Spessore 1.5 mm  
Larghezza 19 mm

CODICE	Lunghezza mm	Materiale	Pz. Conf
<b>AT36 6</b>	60	Ferro zincato	1-100
<b>AT37 8</b>	80	Ferro zincato	1-100
<b>AT38 10</b>	100	Ferro zincato	1-100

## ART. 148

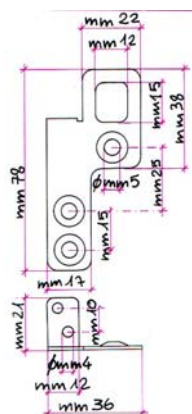

## ART 276

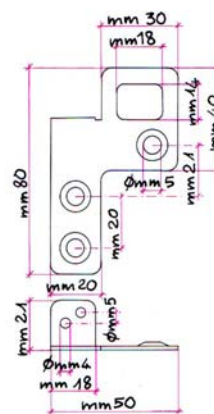
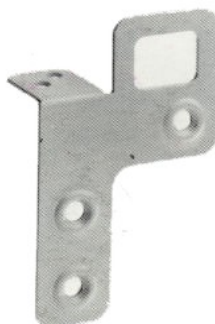

CODICE	Materiale	Pz. Conf
<b>AT148</b>	Ferro zincato	1-200 DX 1-200SX
<b>AT276</b>	Ferro zincato	1-200 DX 1-200SX

**VENDUTE SOLO A COPPIA**

## ART. 266

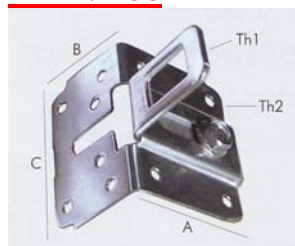

CODICE	A mm	B mm	C mm	Th1	Th2	Materiale	Pz. Conf
<b>AT266</b>	45	36	51	2.5	1.2	Ferro zincato	1-200

## ART. 268

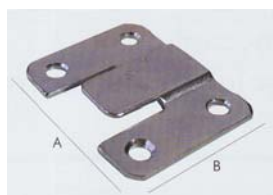

## ART. 269

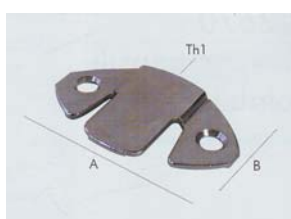

CODICE	A mm	B mm	Th1	Materiale	Pz. Conf
<b>AT268</b>	43	35	1,5	Ferro zincato	1-200
<b>AT269</b>	40	25	1,5	Ferro zincato	1-200